

**STUCCO BLDG A&B**

**STUCCO BLDG C**

**METALS**

**ACCENT & MATERIALS**

**DETAILS**

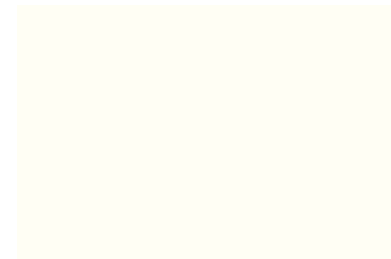

① **COLOR 1 (BODY 1)**  
KELLY-MOORE  
KM3489  
PALE IVORY

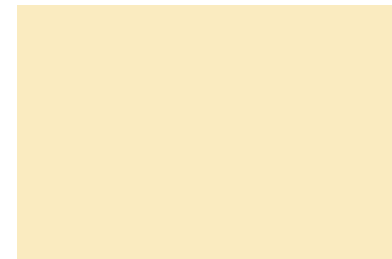

④ **COLOR 4 (BODY 1)**  
KELLY-MOORE  
KM4180  
BRITTANY BEIGE

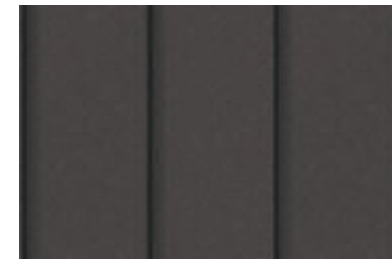

⑦ **ROOF**  
METAL ROOF



⑩ **STONE (BLDG A & B)**  
ELDORADO STONE



② **COLOR 2 (BODY 2)**  
KELLY-MOORE  
KM3541  
HACIENDA CLAY



⑤ **COLOR 5 (BODY 2)**  
KELLY-MOORE  
KM4014  
TUMBLE TAN

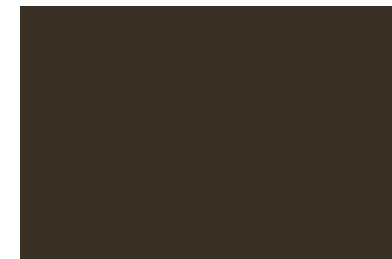

⑧ **METAL 1 (WIND A & B)**  
KAWNEER  
ORSL 42958  
SEPIA BROWN



⑪ **WOOD 1 (SOFFIT)**  
"NICHIHA" VINTAGE WOOD "CEDAR"



③ **COLOR 3 (ACCENT)**  
SHERWIN WILLIAMS  
SW7033  
BRAINSTORM BRONZE



⑥ **COLOR 6 (ACCENT)**  
KELLY-MOORE  
407  
CARBON

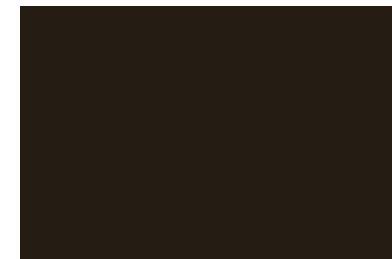

⑨ **METAL 2 (WIND C)**  
KAWNEER  
UC 109850  
CLASSIC BRONZE



⑫ **TRELLIS**  
NATURAL WOOD



Ⓐ **CEILING SOFFIT CONDITION**

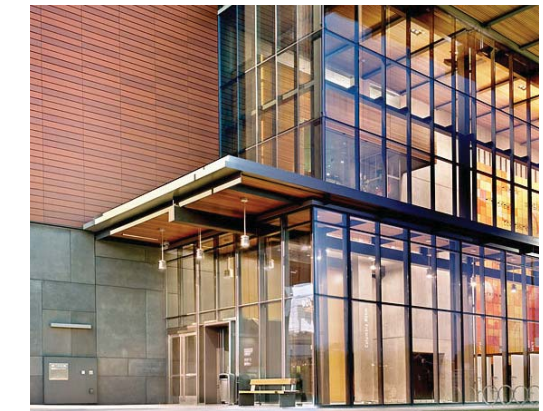

Ⓓ **STOREFRONT WINDOW SYSTEM**



Ⓑ **STONE CAP DETAIL**



Ⓔ **STONE BASE**



Ⓒ **BALCONY RAILING**



Ⓕ **EXTERIOR LIGHT**  
VISA LIGHTING: WALL SCONCE, 23 FIXTURES  
150 W MAX, 10" x 33" x 13"

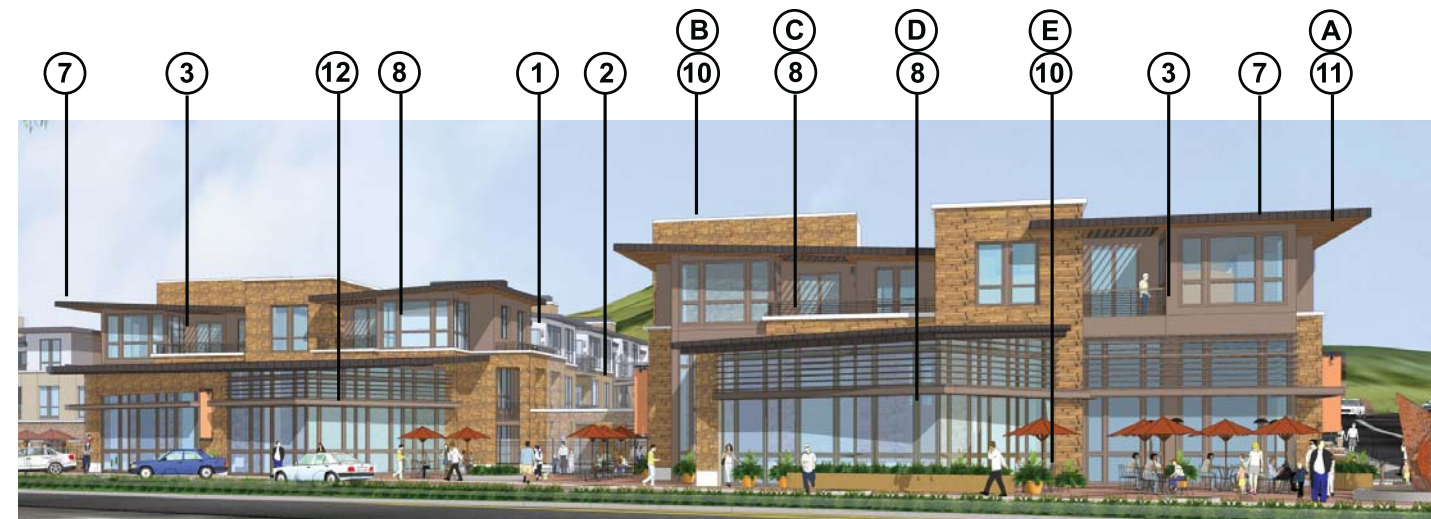

Architecture  
Planning  
Urban Design  
304 12th Street, Suite 2A  
Oakland, California 94607  
(510) 451-2850

3666, 3672 & 3682 Mt. Diablo Boulevard  
Lafayette, California

Lennar

Sheet Title:

**DETAIL EXAMPLES**

Job No. 13003  
Date: 10/20/2014  
Scale:  
Drawn By:

Sheet No:

**A4.1**



11 COURTYARD FOUNTAIN #1



12 COURTYARD FOUNTAIN #2



14 DECORATIVE METAL ENTRY FENCE GATES TO MATCH



23 6' WOOD FENCE



22 5'0" HIGH POOL FENCE IN BRUSHED ALUMINUM 'OMEGA' FENCE



16 BUILT-IN BENCH: FF1018 CURVED SCROLL 'FACTORY FURNITURE'



17A 6' FREESTANDING STREETScape BENCH 'TIMBERFORM' SITE FURNISHINGS #2141



17 6' FREESTANDING BENCH (COURTYARD SPACES) 'DUMOR' SITE FURNISHINGS #472-60



28 PLANTER POTS (VARIOUS SIZES) 'TOURNESOL' PRODUCTS URBAN COLLECTION-AGED BRONZE

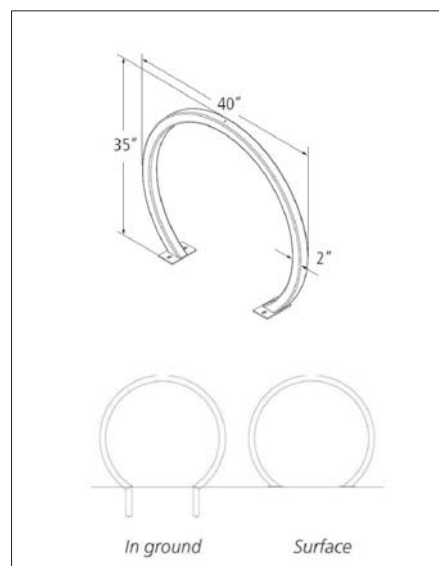

33 BICYCLE RACK



26 PAVER #3 UNI-GROUP 'SUPER-DECOR' FROM HOKANSON BUILDING BLOCK CO.



27 PAVER #4 'MEGA-LAFITT ASHLAR PATTERN BELGARD PAVERS

25 PAVER #2 'MEGA-LAFITT 18" SQUARE ONLY

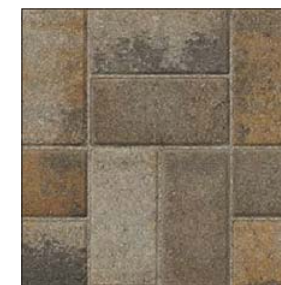

COLOR FAMILY FOR PAVERS

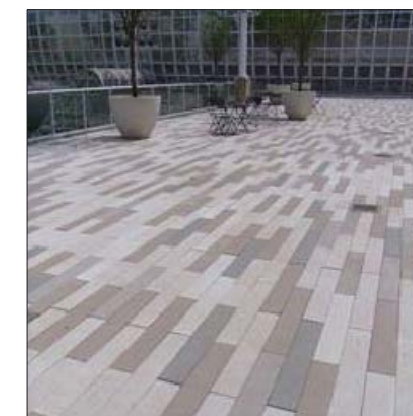

24 PAVER #1 PRIVATE PATIOS: PLANK PAVER (BROWN COLOR ONLY) 'WAUSAU PAVING'



5 TREE GRATE: ADA 48" SQ. TREE GRATE IN ALUMINUM. 'IRONSMITH'

REVISIONS	
NO.	DATE
1	10-20-14

Thomas Brink & Associates, L.L.P.  
 Landscape Architects  
 1620 North Main Street, Suite 4  
 Walnut Creek, CA 94596  
 Ph: 925.933.2263



3666,3672 MT. DIABLO BLVD  
 LAFAYETTE, CALIFORNIA

LENNAR

SITE AMENITIES  
 IMAGES

DESIGNED:	DRAWN:
CHECKED:	JOB NO.:
DATE 07-24-14	
SCALE	

SHEET  
 L.2  
 OF SHEETS